

RYSUNKI I SZKICE URZĄDZEŃ SKŁADAJĄCYCH SIĘ NA PLAC ZABAW W KLECEWKU

GMINA RYJEWO

W O T

mgr Józef Gutowski

ZESTAW 11

zestaw dla **18** dzie

w skład zestawu wchodzi:

- 1 Wieża z dachem dwuspadowym
- 1 Zjeżdżalnia głęboka
- 7 Zabezpieczeń
- 1 Podest
- 3 Platformy
- 2 Uchwyty boczne
- 2 Wejściówki
- 1 Rurka nad zjeżdżalnią
- 1 Przeplotnia drewniana
- 1 Drabina
- 1 Rura strażacka
- 1 Pomost z belką

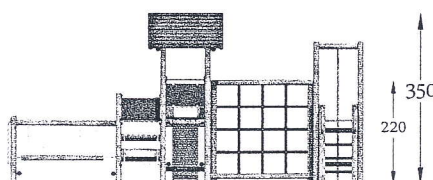
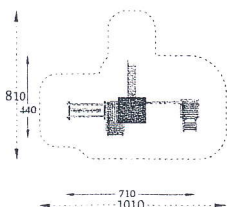
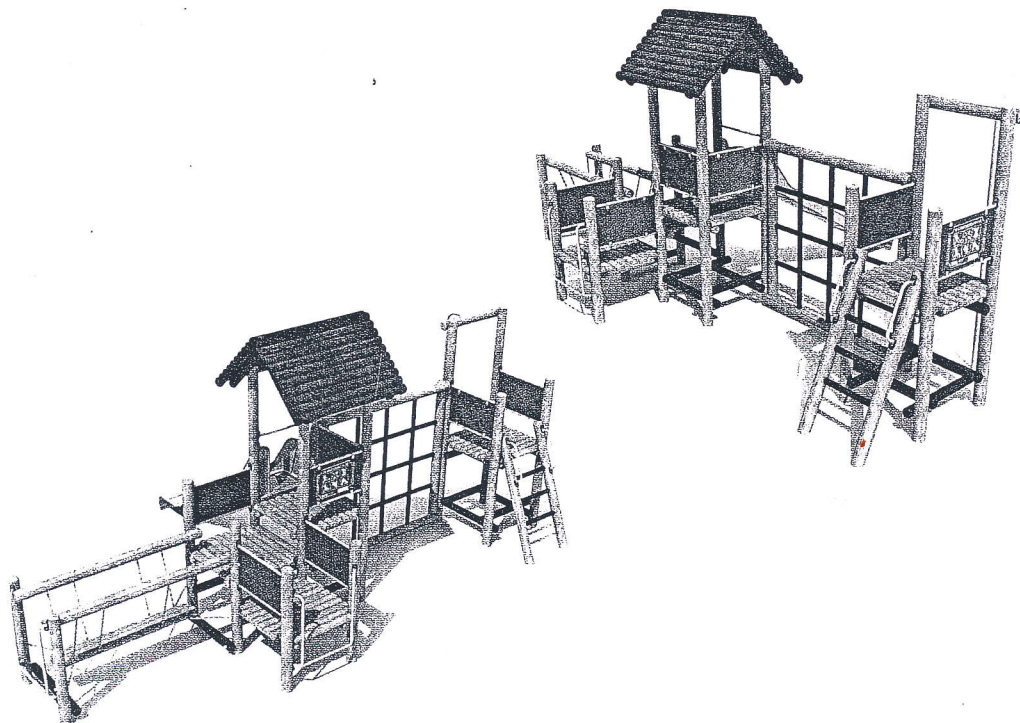

BEZPIECZNA NAWIERZCHNIA

Pole strefy bezp.:	56 m ²
Obwód strefy bezp.:	32 mb
Maks. wysokość upadku:	2.2 m

KARUZELA
KRZYŻOWA

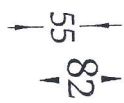
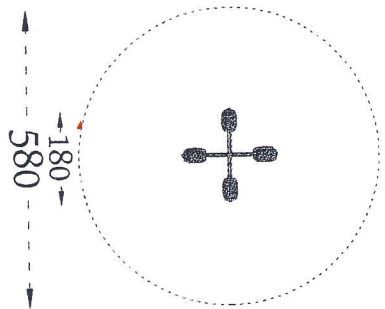
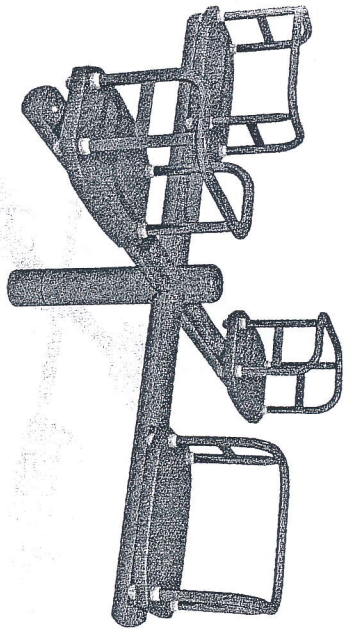

Huśtawka
Pojedyncza drewniana

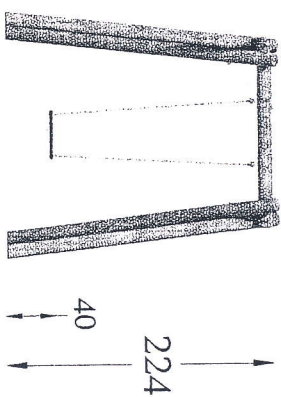
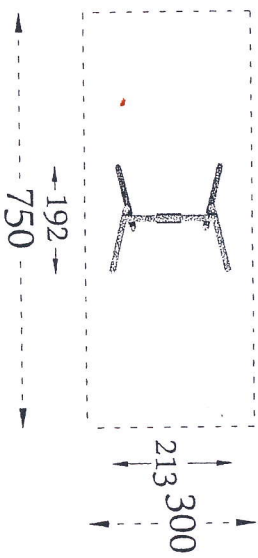
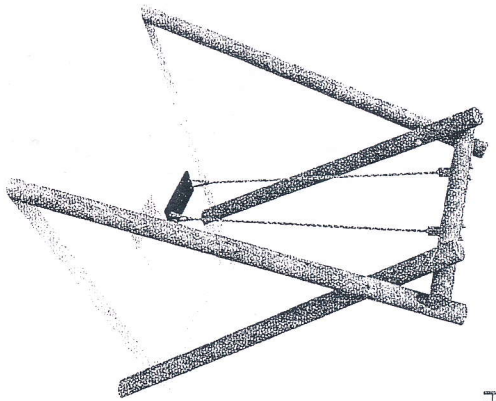

Huśtawka
Podwójna drewniana

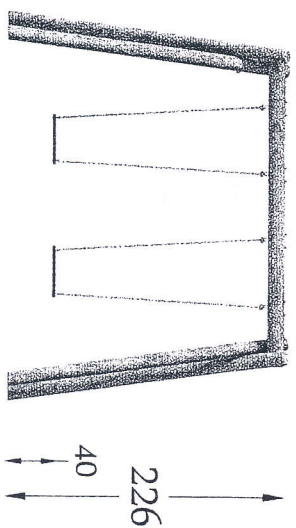
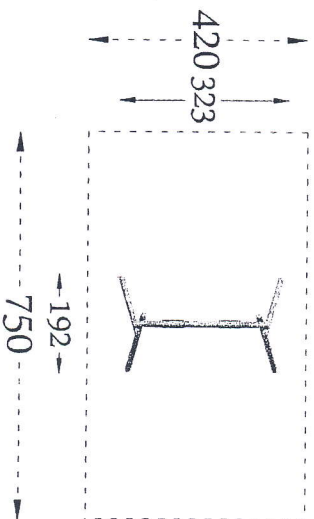
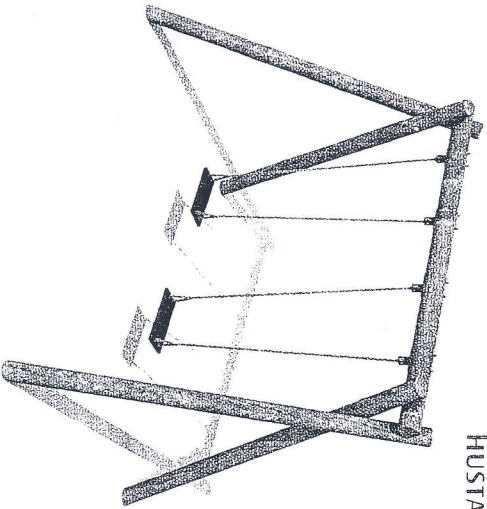

HUŚTAWKA
WAŻKA

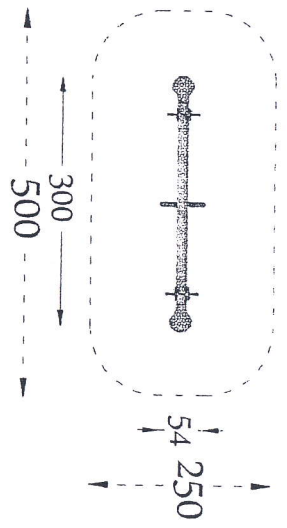
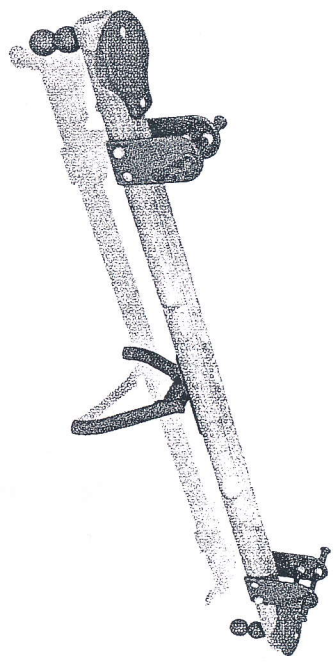

SPRĘŻYNOWIEC
KONIK

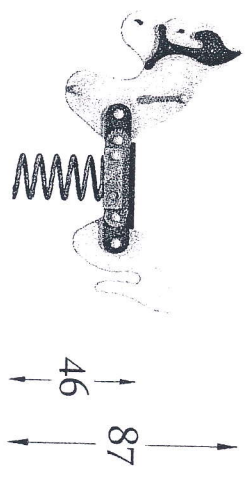
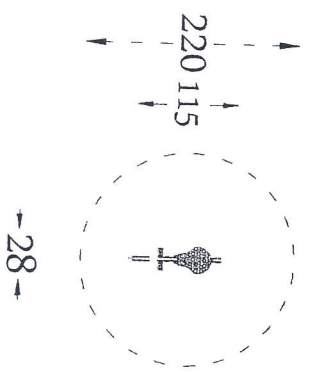
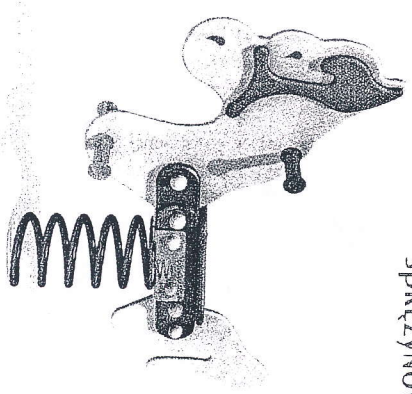

SPRAWNOŚCIOWE
LINARIUM STOŻEK

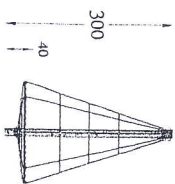
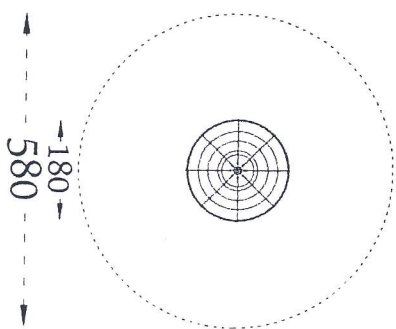
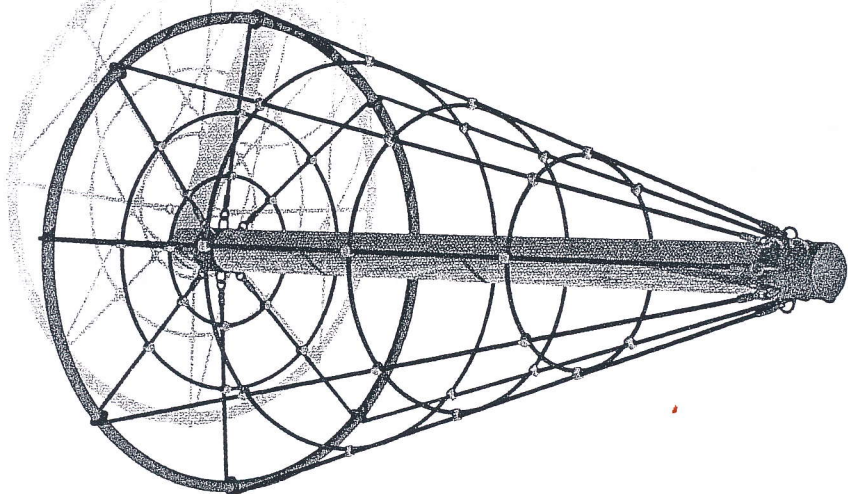

AKCESORIA
KOSZ NA ŚMIECI Z PÓŁWAŁKÓW

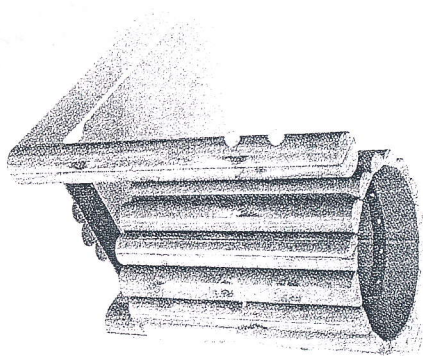

70

48



5

AKCESORIA
PŁOTEK POZIOMY

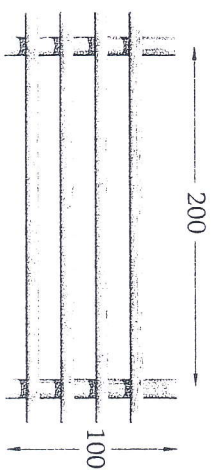
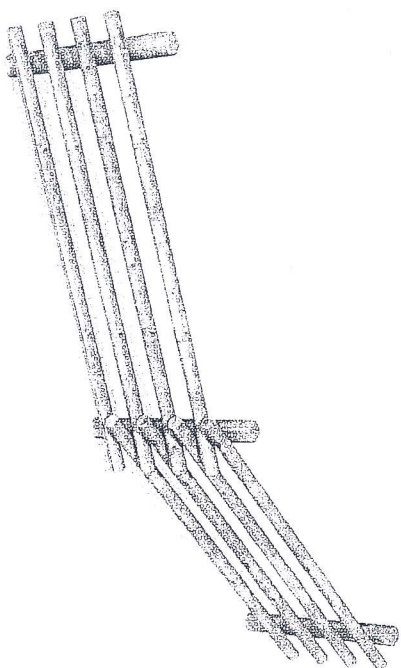

200

100

drabinka
POZIOMA

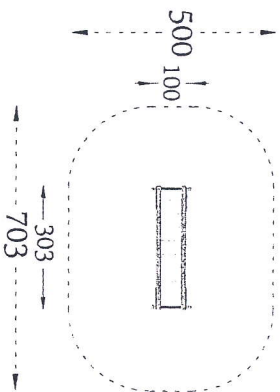
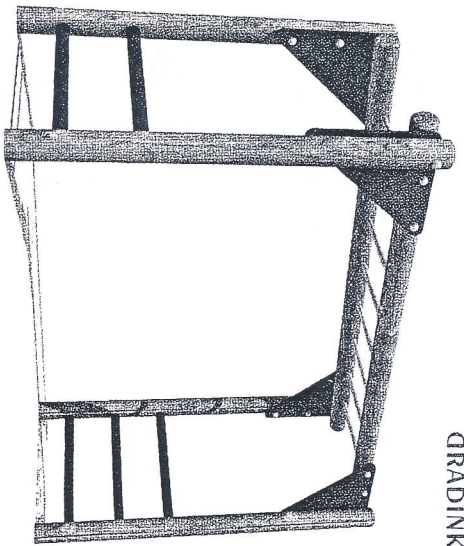

ławka
Z bali stała z oparciem

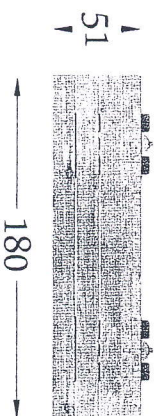
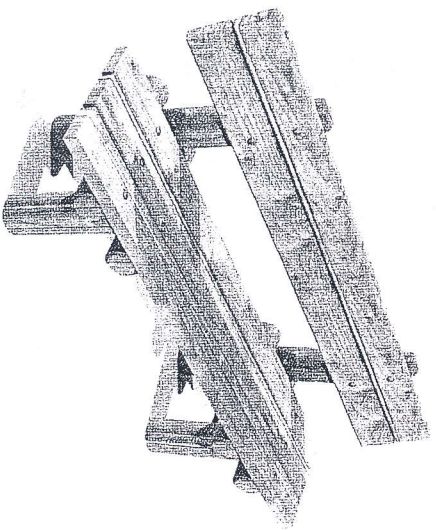



Miejs Kłeczeńsko
Zestaw zabawowy

- 1) sprzętynance
- 2) huśtawka narętko
- 3) huśtawka podłużna alternująca
- 4) huśtawka pół okrągła
- 5) kołozłota bryłkowa
- 6) huśtawka stojkowa
- 7) drabinka pozioma
- 8) Ficus z bali stule z opryciem
- 9) kaski z piłkami

— przebieg mps. Am z bali poziomym
przebieg dm

GMINA RYJEWÓ

W O J T

mgr Józef Grolowski

[Signature]